

Pedisystems[®]

High performance entrance flooring
and dirt containment systems



EXTERIOR ENTRANCE | INTERIOR ENTRANCE | CLEAN-OFF CARPET



Construction Specialties[®]

Pedisystems®

High performance entrance flooring systems

Selecting an entrance mat to fit the form and function of your building is easy with **PEDISYSTEMS®**. From the most luxurious entrance to the more modest, there is a **PEDISYSTEMS®** entrance mat for every project and budget.

Our range of entrance matting systems are designed to remove dirt and moisture at the entrance, helping you; reduce slip incidents on internal floors, extend the life of interior floor finishes and minimise internal cleaning costs.

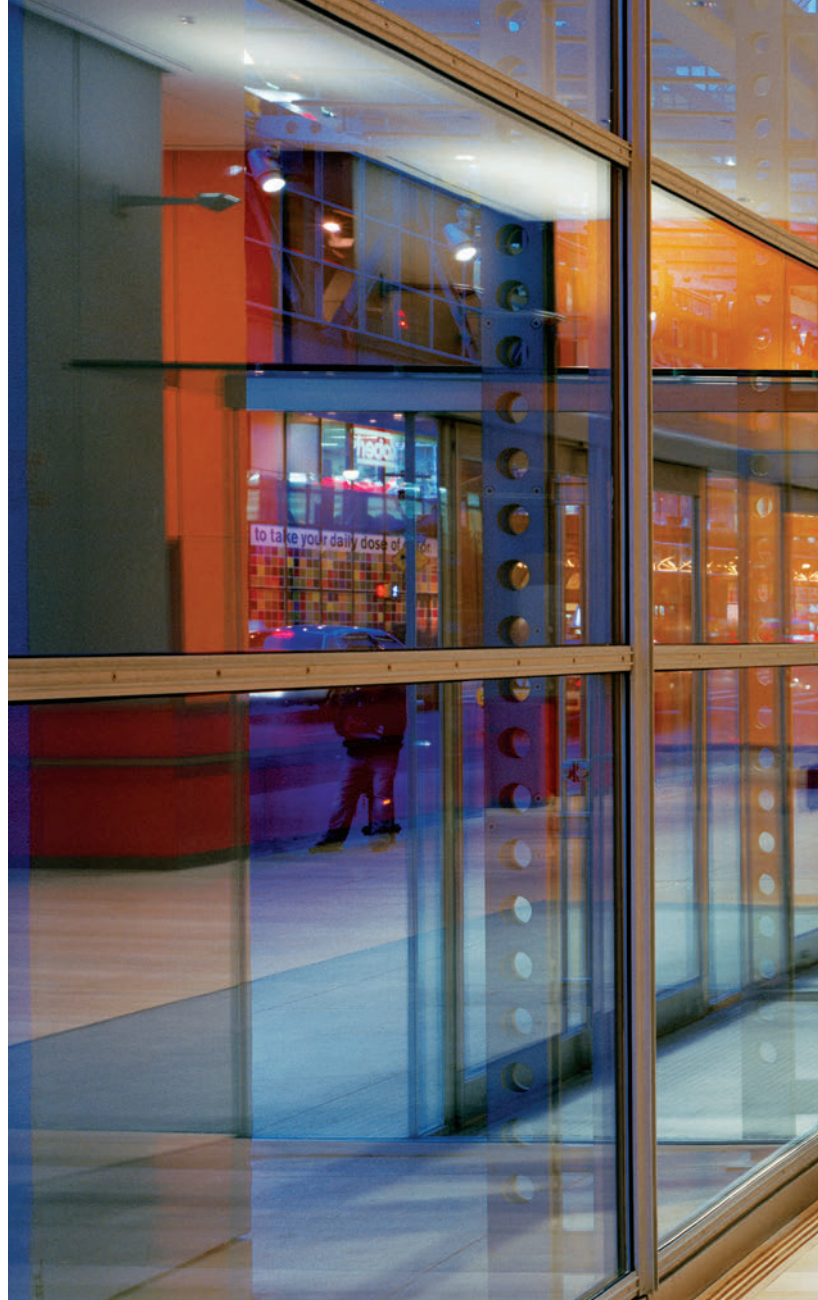

EXTERIOR OF ENTRANCE

First and foremost dirt removal and containment barrier

Characteristics:

- Efficient removal of dirt, mud, grime, slush and initial moisture before entering the building
- Extremely tough wearing and weather resistant
- Designed to retain an excellent appearance under difficult weather conditions
- Its open construction permits optimum dirt hiding and retention, thus reducing cleaning cycles





INTERIOR OF ENTRANCE

Removes and collects dirt immediately inside a building

Characteristics:

- Highly efficient and cost effective dirt containment barrier
- Pedisystems® performance textiles provide for optimum moisture removal
- Rolls up for easy maintenance and cleaning
- Can be installed with or without the use of a matwell

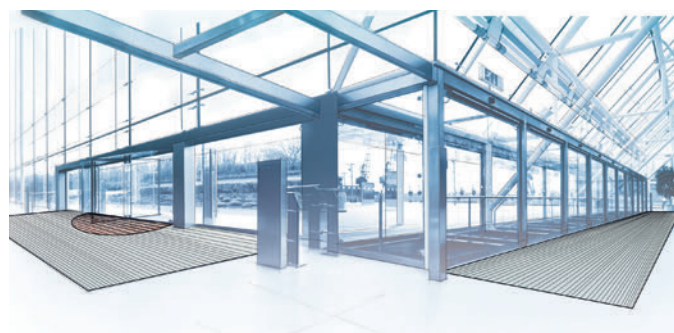

CLEAN-OFF CARPET

Cleans and dries the soles of shoes and tyres of wheeled traffic beyond entrance areas.

Characteristics:

- Prevents dirt tracking from soiled to clean environments within a building
- Its high twist and heat set construction enhances durability
- Rolls up for easy maintenance and cleaning
- Customisable matting



SELECTION GUIDE



PEDIGUARD®
06 - 07

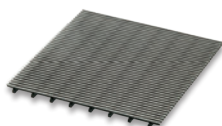

GRIDLINE®
08 - 09

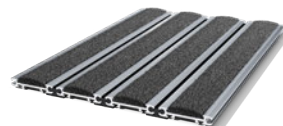

PEDIMAT®
10 - 11

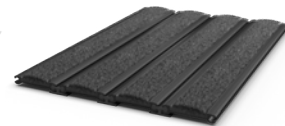

PEDIMAT® ECO
10 - 11

APPLICATIONS

	PEDIGUARD®	GRIDLINE®	PEDIMAT®	PEDIMAT® ECO
Rolling load / wheel	650 kg	250 kg	225 kg	120 kg
Heavy load Heavy traffic	✓ ✓	✓	✓ ✓	—
Medium load Heavy traffic	✓ ✓	✓	✓ ✓	✓
Pedestrian traffic	✓ ✓	✓ ✓	✓ ✓	✓ ✓
Accessibility disabled	✓	✓ ✓	✓	✓

LOCATIONS

	PEDIGUARD®	GRIDLINE®	PEDIMAT®	PEDIMAT® ECO
Weatherproofing / Outdoor	✓	✓	✓	✓
Free standing	✓	✓	✓	✓
Recessed installation (Pit height)	✓ 12-15 mm (CT12) ✓ 17-21 mm (CT18)	✓ 11-17 mm	✓ 12-15 mm	✓ 12-15 mm

PERFORMANCE

	PEDIGUARD®	GRIDLINE®	PEDIMAT®	PEDIMAT® ECO
Dirt trapping	✓	✓ ✓	✓ *	✓
Absorption moisture	✓	✓ ✓	✓ ✓	✓
Storage capacity	—	✓ ✓	—	—
Ease of maintenance	✓	✓ *	✓	✓

CHARACTERISTICS

	PEDIGUARD®	GRIDLINE®	PEDIMAT®	PEDIMAT® ECO
Reversible	✓	—	—	—
Rollable	—	—	✓	✓
Fire rating	✓	✓	—	—
Clip-on on site	—	—	—	—

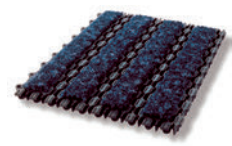
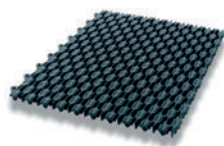
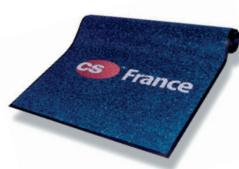
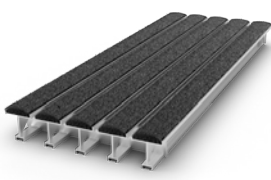
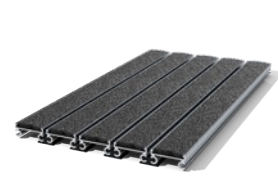

PEDILUXE®
12-13

PEDIGRID®
14 - 15

PEDIFREE® / PEDIFLEX®
16

HELIX® Z1
17

HELIX® Z2
17

500 kg	200 kg	500 kg	500 kg	250 kg	250 kg
—	✓ **	✓	✓	✓	✓
✓	✓ **	✓ *	✓ *	✓ *	✓ *
✓ *	✓ **	✓ **	✓ **	✓ **	✓ **
✓ *	✓ **	✓ *	✓ *	✓ *	✓
✓	✓	—	—	✓	✓
✓	✓	✓	—	✓	✓
✓ 17-21 mm	✓ 44 mm	—	✓ 12-15 mm	✓ 12-15 mm	✓ 12-15 mm
✓ **	✓ **	✓ **	✓ **	✓ *	✓ *
✓ **	✓ **	✓ **	✓ **	✓ **	✓ **
✓ *	✓ **	—	—	✓	✓
✓ **	✓ *	✓ *	✓ *	✓ *	✓ *
—	—	—	—	—	—
✓	✓	✓	✓	—	—
—	—	—	—	—	—
—	—	—	—	✓	✓

PEDIGUARD® | Extreme performance for exteriors & interiors

PEDIGUARD® is a 12mm or 18mm deep custom manufactured construction and offers the highest grade of stability and resistance to wear, while constituting an extremely versatile and effective barrier to the infiltration of soil and moisture into buildings.



Continuous, solid treads offer unsurpassed resistance to heavy, rolling equipment, making Pediguard® ideal for airport terminals, shopping centres, hospitals, etc.



PEDIGUARD® 18

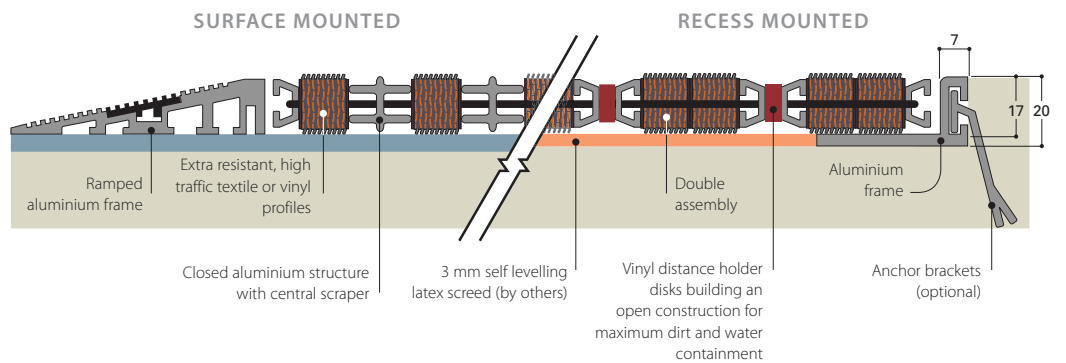



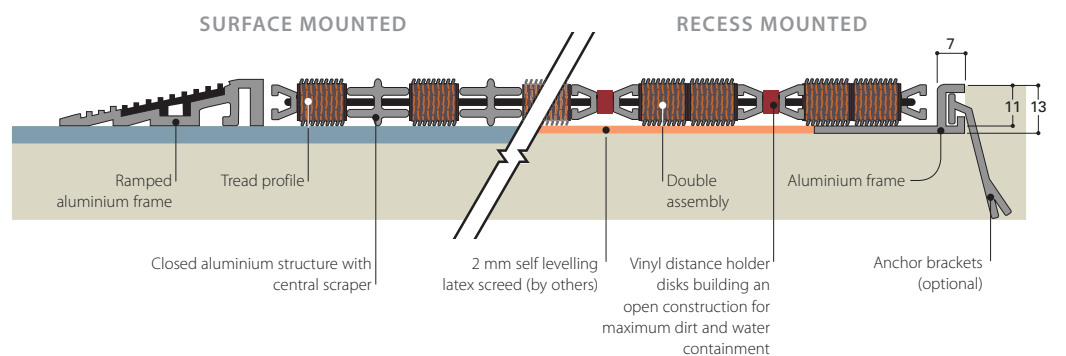
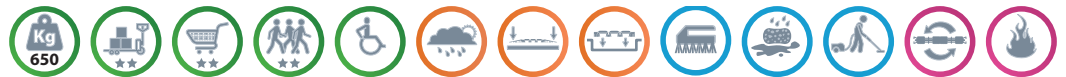



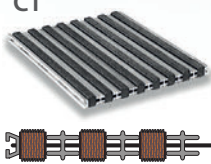
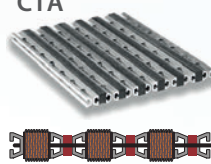
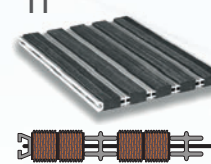
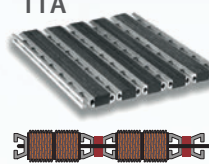

PEDIGUARD® 12

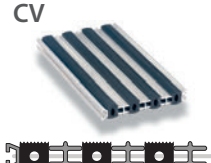
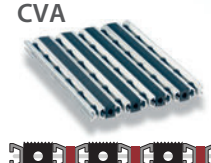

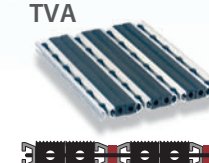
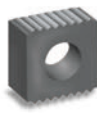

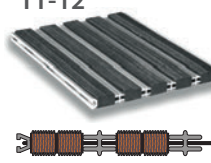
FINISHES

PEDIGUARD® 18 INTERIOR - EXTERIOR	CT 	CTA 	TT 	TTA 	ALUMINIUM Anodised  Colourless
	CV 	CVA 	TV 	TVA 	EXTERIOR Vinyl  Black
PEDIGUARD® 12 INTERIOR - EXTERIOR SHELTERED	CT-12 	CTA-12 	TT-12 	TTA-12 	INTERIOR Textile  Gray

ACCESSORIES

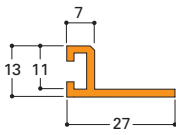
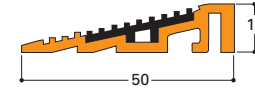
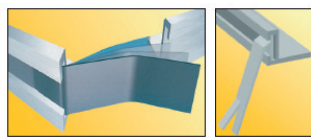
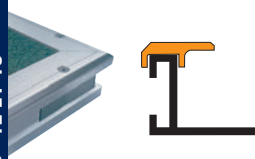
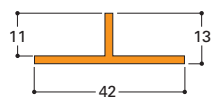
PEDIGUARD® 12 FRAME  Dimensions: 7, 13, 11, 27	PEDIGUARD® 12 RAMPED ALUMINIUM FRAME  Dimensions: 50, 11	PEDIGUARD® 12 ET 18 FRAME ACCESSORIES  Assembly and fixing kit supplied with the frame. Flexible assembly brackets and anchor brackets (optional)	PEDIGUARD® 12 ET 18 FRAME CAPPING SECTION  T-FRAME  Dimensions: 11, 13, 42
--	--	--	--

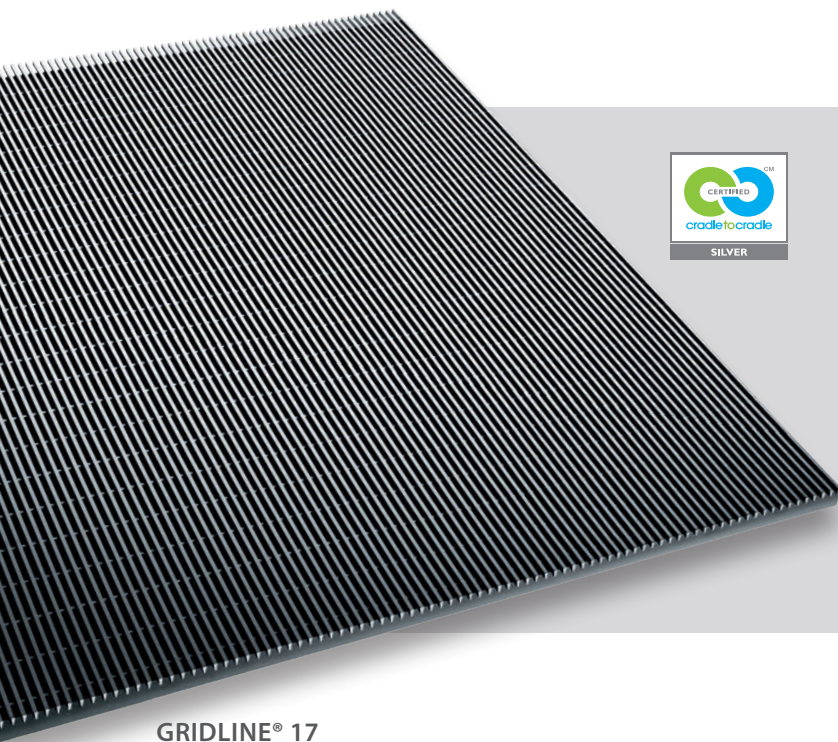

GRIDLINE® is available in 11mm or 17mm depths and can be used indoors and outdoors (zones 1 and 2).

GRIDLINE® is constructed from hard wearing grade 304 stainless steel and provides years of durable scraping performance whilst maintaining a great aesthetic.

GRIDLINE® PLUS combines a larger version of the wedge scrapers with interior carpet inserts.

GRIDLINE® 17

GRIDLINE® 11 AND 17



SURFACE MOUNTED

RECESS MOUNTED

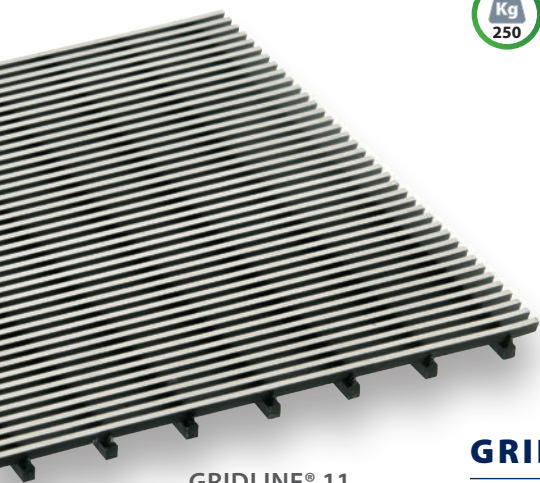
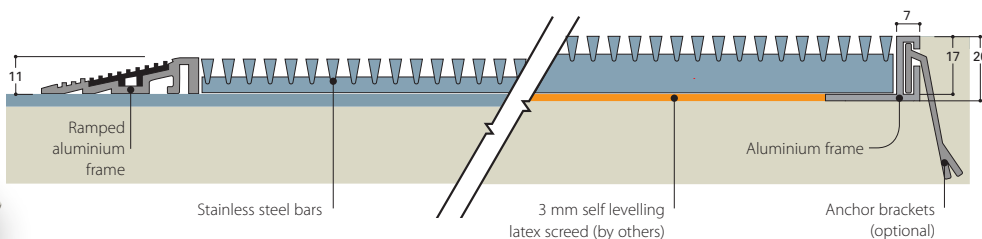

GRIDLINE® 11

GRIDLINE® PLUS 17



SURFACE MOUNTED

RECESS MOUNTED

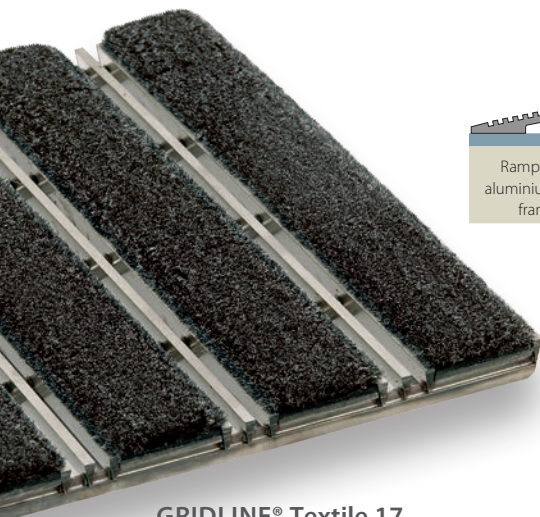
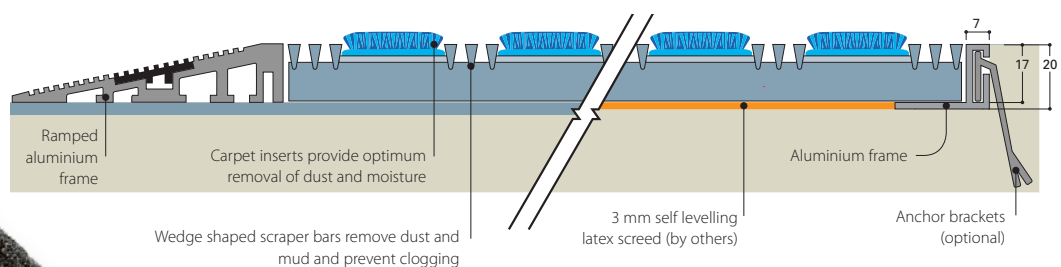

GRIDLINE® Textile 17

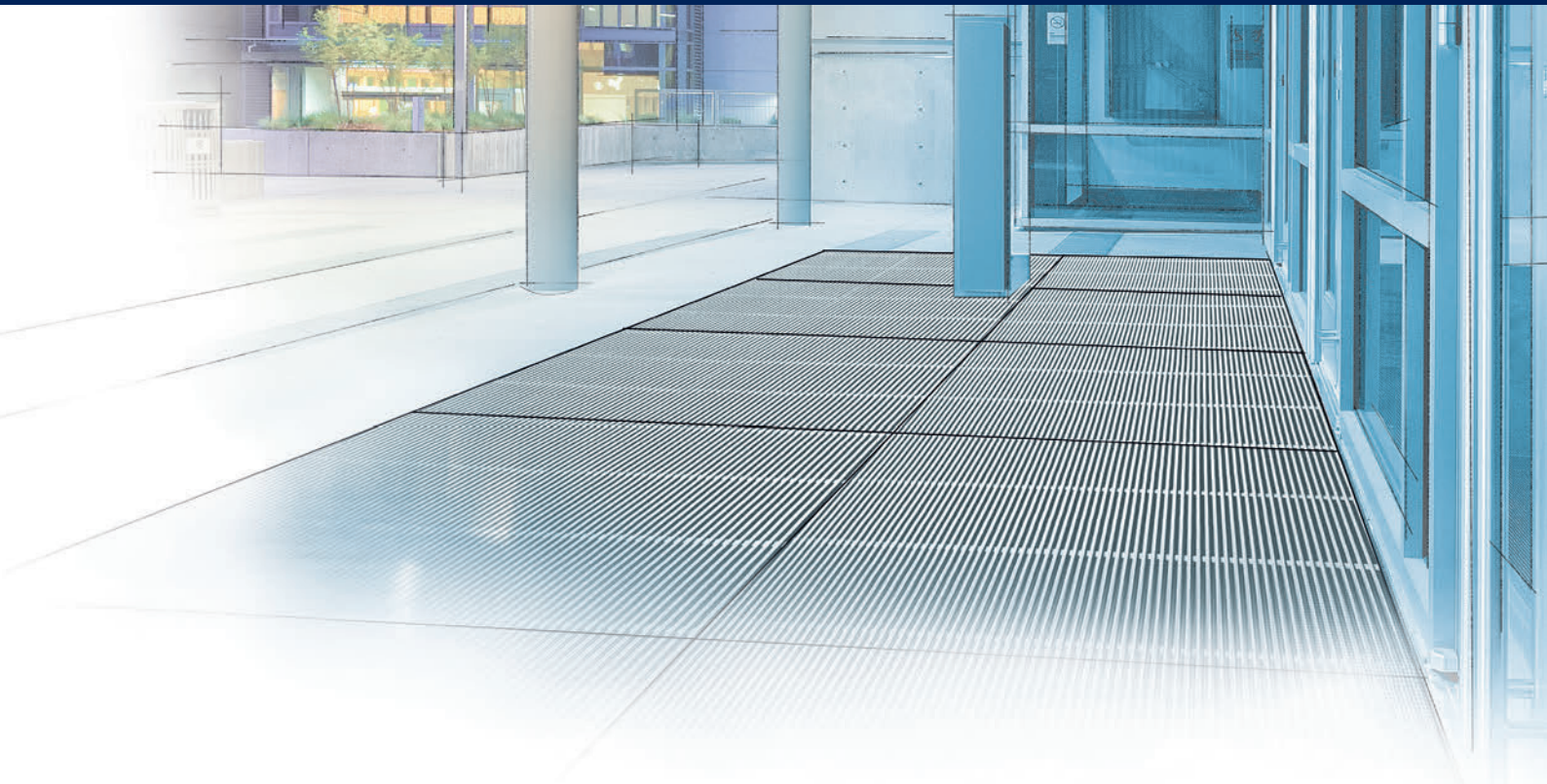

ACCESSORIES

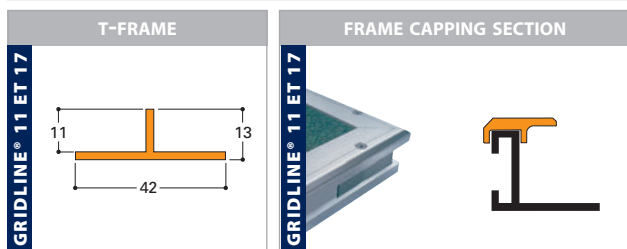
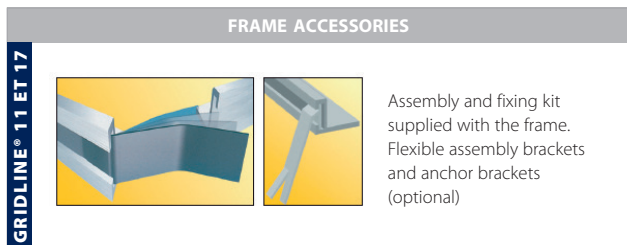
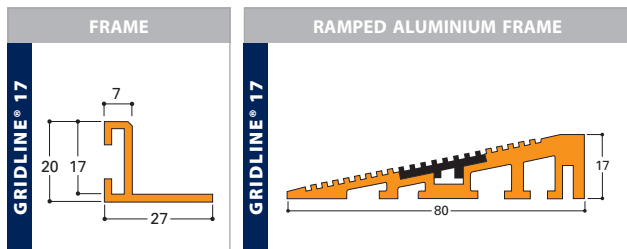
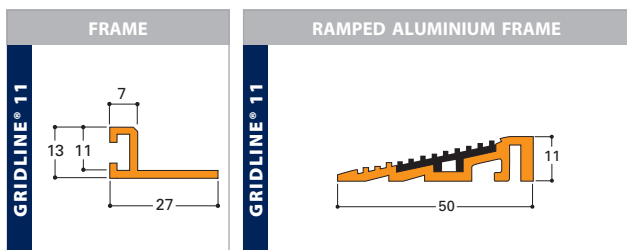

INSERTS



FINISHES



PEDIMAT® | High efficiency against dirt and moisture



PEDIMAT® is the perfect entrance matting solution for buildings in moderate use such as offices, shops, hotels, banks and building societies..

PEDIMAT® can be recessed or surface mounted, either in a ramped frame or to butt level with a surrounding carpet.

PEDIMAT® 13

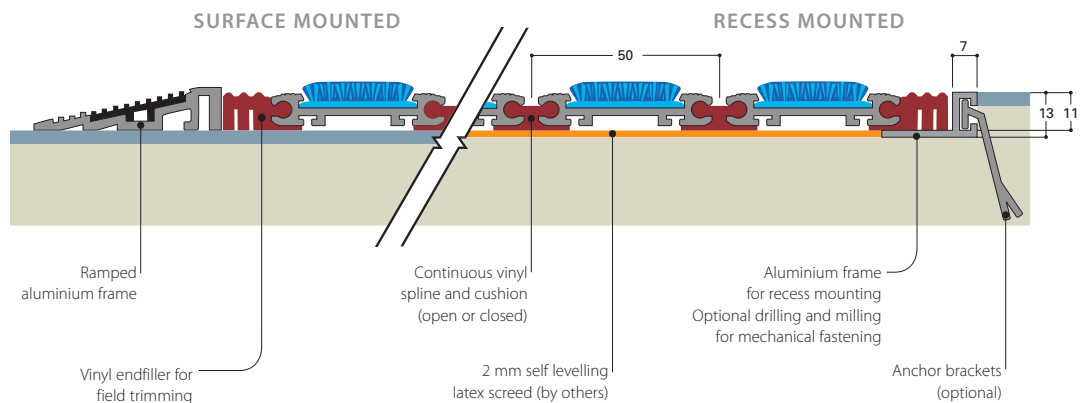





PEDIMAT® 13 ECO





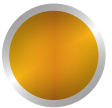

The **PEDIMAT®ECO** is aimed primarily inside although it can be integrated into covered exterior thanks to its structural strength. Combining a black polycarbonate profile to hinge vinyls, the **PEDIMAT®ECO** offers the best compromise between price and performance while being easy to handle thanks to its lightweight structure.



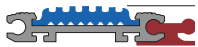

ALUMINIUM

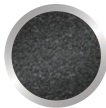
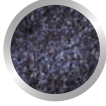
MILL FINISH	ALUMINIUM ANODISED			
				
Aluminium	Colourless	Gold	Bronze	Black

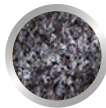
INSERTS

INTERIOR - EXTERIOR		INTERIOR
VINYL	ABRASIVE	CARPET
		
		
Gunmetal Grey	Ocean Grey	Aqua Green
		
Black	Black	Indigo
		
Forest Green		Middle Grey
		
		Graphite

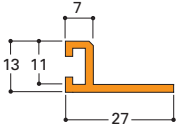
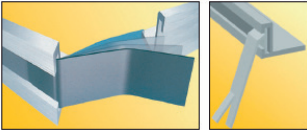
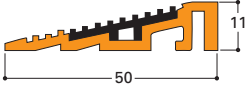
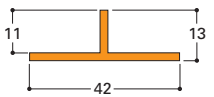
ACCESSORIES

FRAME	FRAME ACCESSORIES	RAMPED ALUMINIUM FRAME
		
T-FRAME	Assembly and fixing kit supplied with the frame. Flexible assembly brackets and anchor brackets (optional)	RECESS MOUNTED FRAME CAPPING SECTION
		

PEDILUXE® | Versatility and functionality

PEDILUXE®

is our most versatile aluminium entrance matting system. It combines rugged construction with a luxury 'feel' underfoot. Its exceptional load bearing capability makes it especially suitable for high volume areas.

Its exceptional load bearing capability makes it especially suitable for high volume areas. At 20mm deep it fits directly into most existing matwells.



Aluminium rail provides excellent rolling load strength.

Vinyl splines act as hinges allowing Pediluxe® to be rolled up for swift and effortless matwell cleaning.



PEDILUXE® 20



SURFACE MOUNTED

RECESS MOUNTED

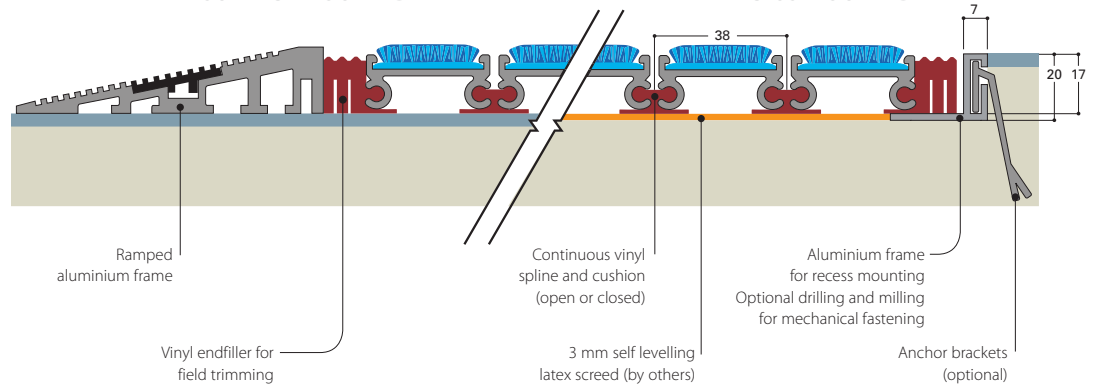

ALUMINIUM

MILL FINISH



Aluminium

ALUMINIUM ANODISED



Colourless



Gold

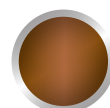

Bronze



Black

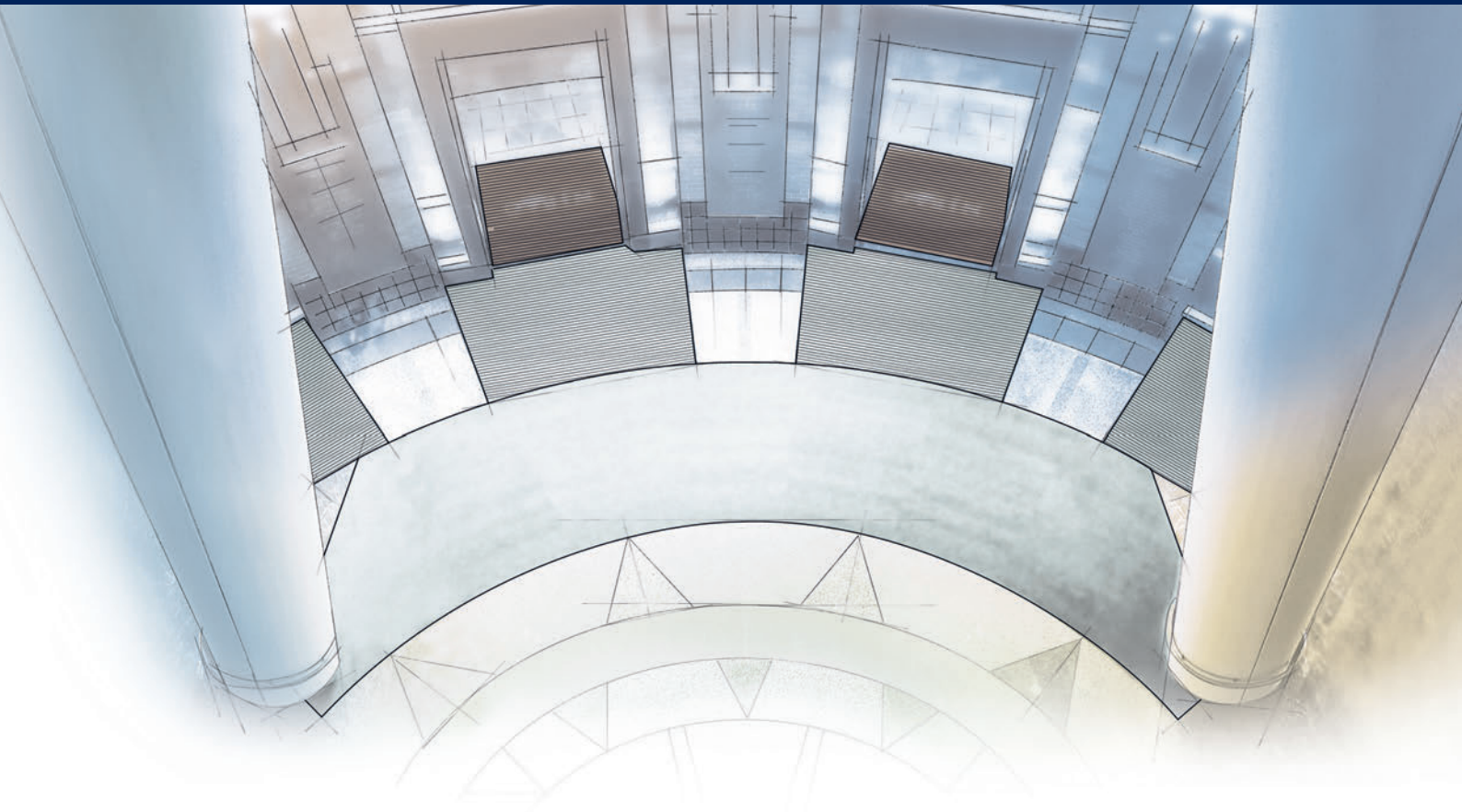

INSERTS

INTERIOR - EXTERIOR		INTERIOR
VINYL	ABRASIVE	CARPET
 Gunmetal Grey Black Forest Green	 Ocean Grey Black	 Espresso Aqua Green Indigo Middle Grey Graphite

ACCESSORIES

FRAME 	FRAME ACCESSORIES <p>Assembly and fixing kit supplied with the frame. Flexible assembly brackets and anchor brackets (optional)</p>	POSITIONING WEDGE
T-FRAME 	RAMPED ALUMINIUM FRAME 	FRAME CAPPING SECTION

PEDIGRID® | High storage capacity, high traffic resistance

Designed exclusively for recessed installations, **PEDIGRID®** is a system of removable grille sections that can be suitable for internal & external use.

PEDIGRID® allows water, dirt, and snow to fall between the heel proof treads into a drainable 46mm deep well below, is reduced cleaning and maintenance.

PEDIGRID® is purpose made to specific modular dimensions and shapes for your project.



Structure en aluminium brut.

PEDIGRID® 46

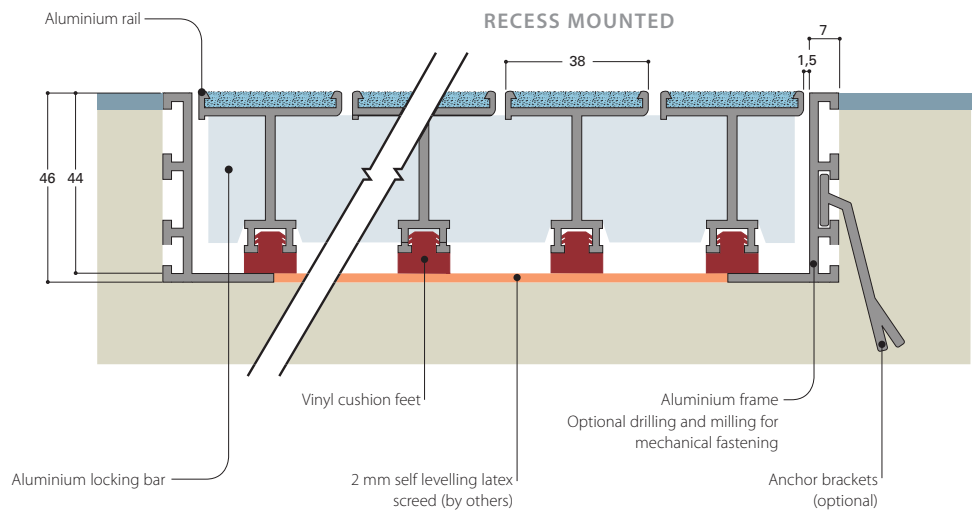

ALUMINIUM





INSERTS

INTERIOR - EXTERIOR			INTERIOR
VINYL	ABRASIVE	SERRATED ALUMINIUM	CARPET
<p>Gunmetal Grey</p> <p>Black</p> <p>Forest Green</p>	<p>Ocean Grey</p> <p>Black</p>	<p>Aluminium</p>	<p>Espresso</p> <p>Aqua Green</p> <p>Indigo</p> <p>Middle Grey</p> <p>Graphite</p>

ACCESSORIES

FRAME FOR RECESS MOUNTING	FRAME ACCESSORIES	RECESS MOUNTED FRAME CAPPING SECTION
	<p>Assembly and fixing kit supplied with the frame. Flexible assembly brackets and anchor brackets (optional).</p>	

PEDIFREE®/ FLEX® | High performance clean-off carpet

PEDIFREE®/FLEX® clean-off carpet is a 10 mm thick, fire rated vinyl (VFR) backed textile matting that has been specially developed by CS.

PEDIFREE®/FLEX® clean-off carpet is extremely efficient at removing and trapping moisture.

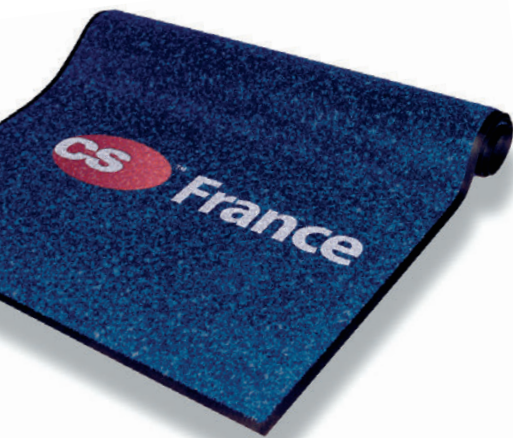
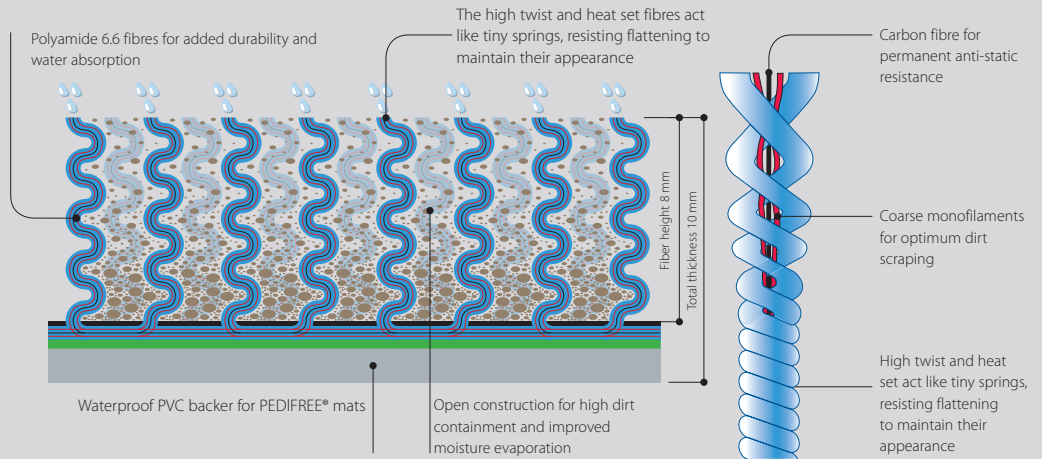

PEDIFREE® SOFT CARPET, EDGED ON 4 SIDES

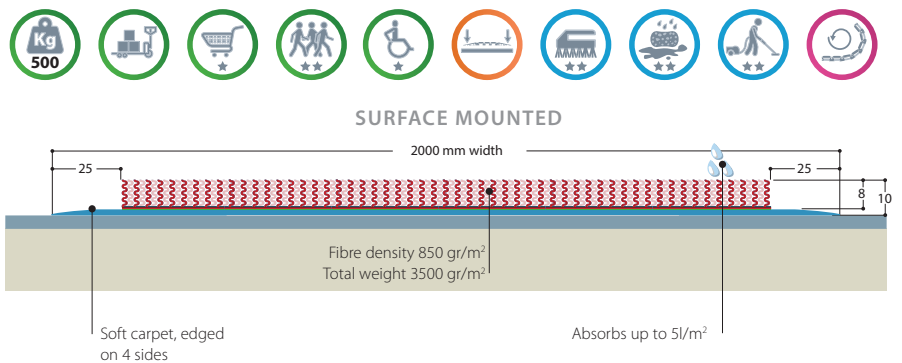

PEDIFLEX® SOFT MAT WITHOUT BORDER

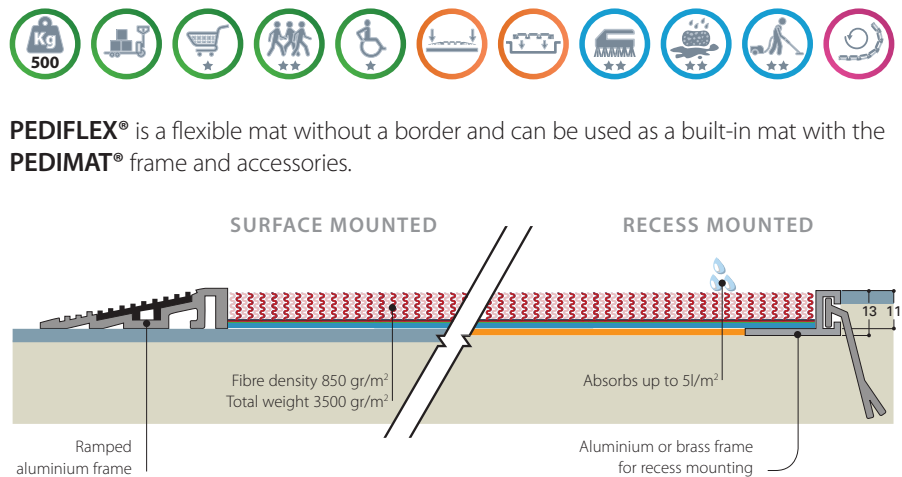

COLOUR CHART



DIMENSIONS

PEDIFREE® - PEDIFLEX®	
ROLLS	2000 mm x 25 ml (width of 2000 mm)
CARPET	Custom-made, with a maximum width of 2000 mm

HELIX® Z1 / Z2 | Interlocking tile system made from recyclable UV

HELIX® Z1 and **Z2** are an interlocking tile system made from recyclable UV resistant PVC/NBR compound which is dimensionally stable and will not shrink or gap.

HELIX® Z2 incorporates interior grade carpet strips, offering high drying and scraping performance.

HELIX® is designed to collect maximum dirt and water.

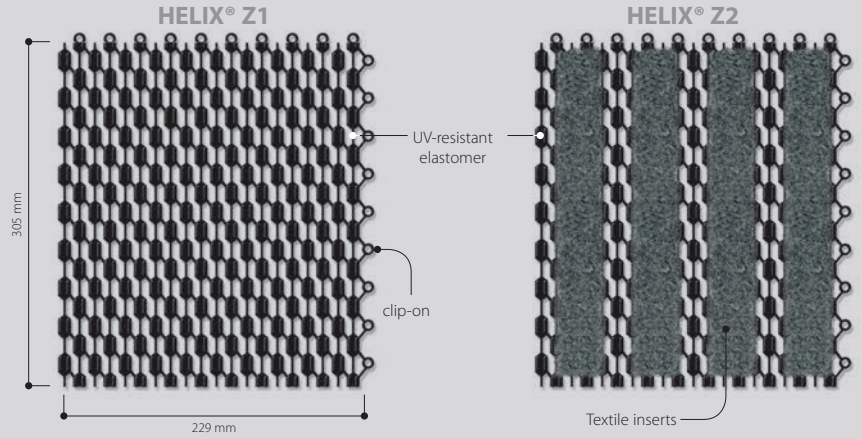

Dimensions: 305 x 229 mm, thickness 11mm.

HELIX® Z1 INTERIOR - EXTERIOR



RECESS MOUNTED

SURFACE MOUNTED

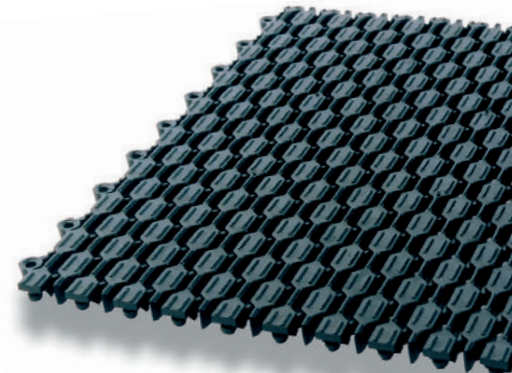
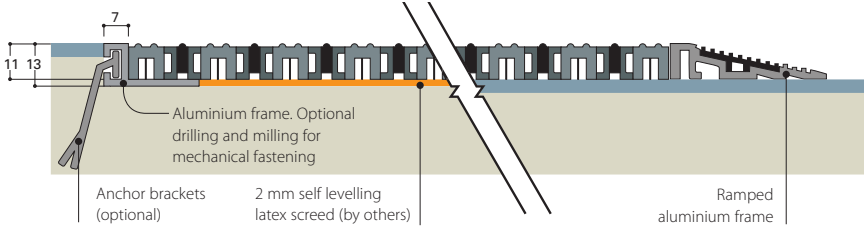

HELIX® Z2 INTERIOR



RECESS MOUNTED

SURFACE MOUNTED

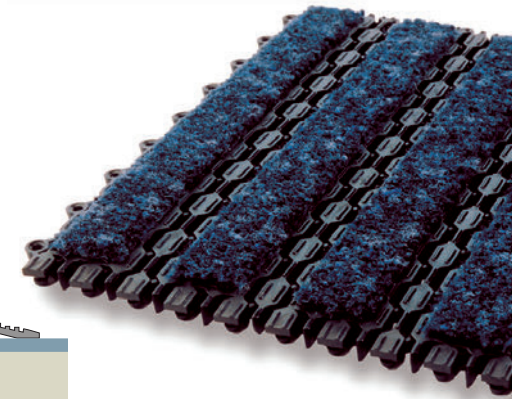
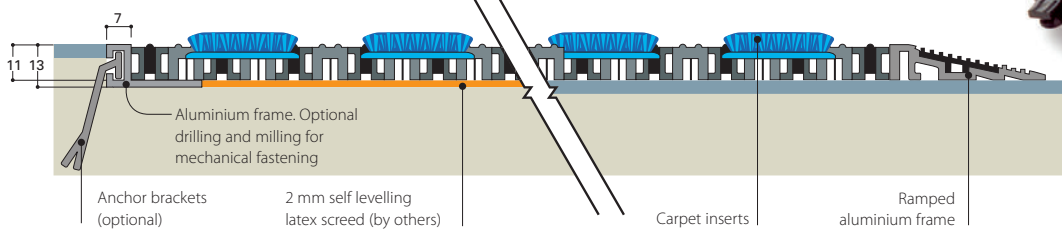

COLOUR CHART



IMPLEMENTATION / MAINTENANCE GUIDE

RECOMMENDATIONS FOR MOUNTING A MAT

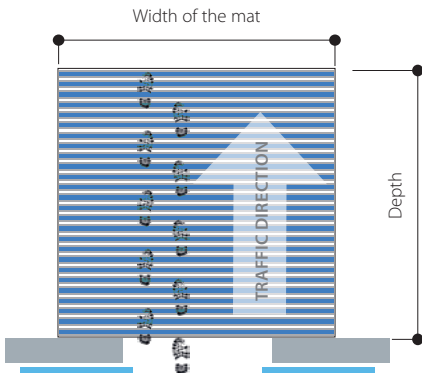

Single module
Wherever possible, CS recommends to use a single module.

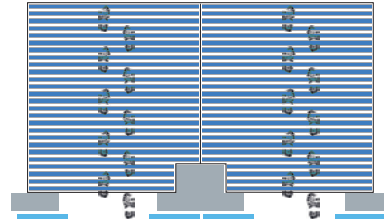

Multiple modules
Upon request or due technical constraints bespoke solutions can be manufactured.

RECOMMENDED MOUNTING

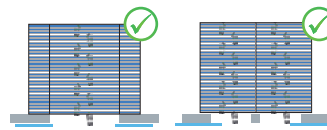

MOUNTING TO BE AVOIDED

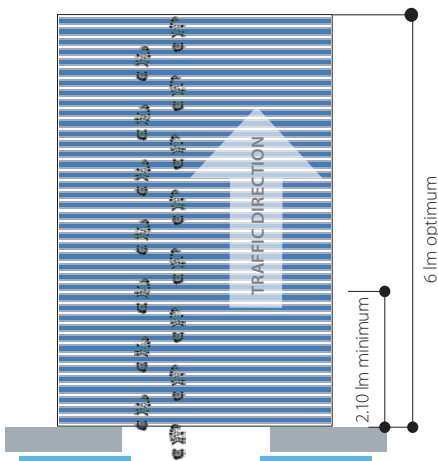

Minimum and optimum length
To be effective, the length of the matting area should be at least 2.10 lm. The optimum length is 6.00 lm.

IMPORTANT: IDENTIFY THE DIRECTION OF TRAFFIC

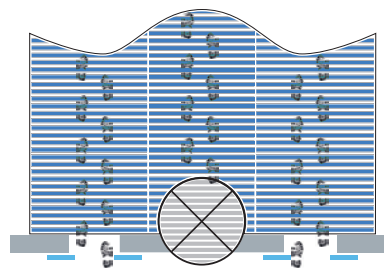

Irregular geometric shapes
to manufacture irregular geometric shapes please provide a precise plan or a non-deformable template (lino, plywood, ...) indicating in all cases the direction of traffic.

DAILY MAINTENANCE



Textile inserts:

Vacuum daily with a powerful suction machine fitted with rotating head brushes. The brushes will agitate the pile, loosening the soiling which is then removed by the suction action.

A single brush machine (vertical axis) must not be used as the twisted structure of the fibres could suffer damage.

Other inserts

After vacuum cleaning, clean with a brush soaked in an aqueous detergent.

For greasy and stubborn stains, moisten the affected surface with a concentrated aqueous detergent and leave to act before brushing. For chewing gum stains, solidify them with crushed ice or a cooling spray then scrape off the hardened stain.

WEEKLY MAINTENANCE



Weekly cleaning of the matwell for Pediluxe and Pedimat is recommended to avoid excessive accumulation of dirt. Monthly cleaning of the matwell for Pedigrind and Pediguard mats is sufficient.

PERIODIC MAINTENANCE



Cleaning by injection/extraction every 1 or 2 months depending on the season. Soak the inserts with soapy water using a high pressure jet (< 80 bars and < 60°C...) in order to loosen the greasy residues and extract the liquefied remains using an aqua-vacuum.

High pressure clean Pediguard® type mats after removing them from the matwell. Allow to dry before reinstalling.

ACCESSORIES GUIDE

PROFILES AND FRAMING ACCESSORIES

FINISHES AND COLOURS

		PEDIGUARD®	GRIDLINE®	PEDIMAT®	PEDILUXE®	PEDIGRID®	PEDIFLEX®	HELIX® Z1 - Z2
FRAME	ALUMINIUM							
	MILL FINISH ANODISED FINISH	✓	✓	✓	•	•	✓	✓
FRAME	ALUMINIUM							
	MILL FINISH ANODISED FINISH	✓	✓	•	✓	•	•	•
FRAME FOR RECESS MOUNTING	ALUMINIUM							
	MILL FINISH ANODISED FINISH	•	•	•	•	✓	•	•
FRAME CAPPING SECTION	ALUMINIUM							
	MILL FINISH ANODISED FINISH	✓	✓	✓	✓	✓	✓	✓
FRAME ACCESSORIES	ALUMINIUM							
	MILL FINISH	✓	✓	✓	✓	✓	✓	✓
RAMPED ALUMINIUM FRAME	ALUMINIUM							
	MILL FINISH ANODISED FINISH	✓	✓	✓	•	•	✓	✓
RAMPED ALUMINIUM FRAME	ALUMINIUM							
	MILL FINISH ANODISED FINISH	✓	✓	•	✓	•	•	•
T-FRAME	ALUMINIUM							
	MILL FINISH	✓	✓	✓	✓	•	✓	•
POSITIONING WEDGE	ALUMINIUM							
	MILL FINISH	•	•	•	✓	•	•	•

CS SOLUTIONS:

Acrovyn® Wall & Door Protection

Acrovyn by Design® Bespoke Wall Protection

Acrovyn® Impact Resistant Doorsets

Pedisystems® Entrance Matting

Omniwall® Interior Partitions

Expansion Joint Covers

Architectural Louvres

Airfoil® Solar Shading

Explovent® Explosion Venting

CS FRANCE

135, Rue Edouard Isambard,
B.P. 66 | 27120 Pacy-sur-Eure Cedex
Tel: +33 2 32 67 00 00
information@c-sgroup.com
www.c-sgroup.eu

WALLPRO AS

Otto Ruges vei 70
1361 Østerås
Norway
Mob. 91511490 / 95901241
info@wallpro.no
www.wallpro.no

